



*making nets work*



# Aviation Wireless Communications

**Chris Wargo**

**Computer Networks & Software, Inc.**

**Presented to  
IAB Workshop on  
Wireless Internetworking  
February 29 - March 2, 2000**

# Agenda



making nets work



- **Today's Aeronautical Telecommunication Network (ATN)**



- **Potential of TCP/IP Architecture for Aviation**
- **Mobility Management Requirements**
- **Summary**
- **Discussion**



# *Wireless Application Categories (Voice and Data)*



- **Air Traffic Management (ATM)**
  - Air Traffic Control (ATC)
  - Air Traffic Services (ATS)
  - Communication, Navigation, & Surveillance (CNS)
- **Airline Operational Communications (AOC)**
  - Flight Operations
  - Maintenance
  - Airport/Ramp Operations
- **Airline Administrative Communications (AAC)**
- **Airline Passenger Communications (APC)**
- **Entertainment**

# *Global Customers of the Wireless Aviation Market*



making nets work



<b>Type</b>	<b>Size Indication</b>
<b>Commercial Aviation</b>	<b>15,000 Aircraft plus ( times # of passengers)</b>
<b>Business Aviation</b>	<b>25,000 Aircraft plus</b>
<b>General Aviation</b>	<b>100,000 Aircraft plus</b>
<b>Cargo Aviation</b>	<b>10,000 Aircraft plus</b>
<b>Military</b>	<b>50,000 Aircraft plus</b>
<b>Government</b>	<b>184 Countries of ICAO</b>

# Aeronautical Telecommunication (ATN) Network Environment



making nets work

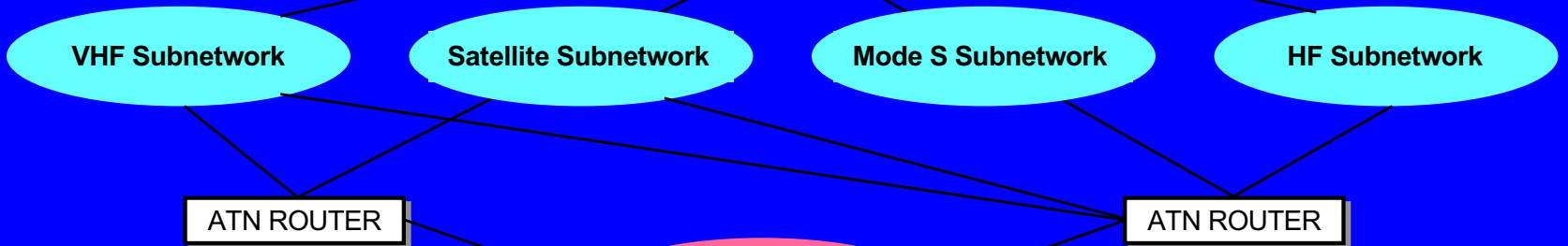
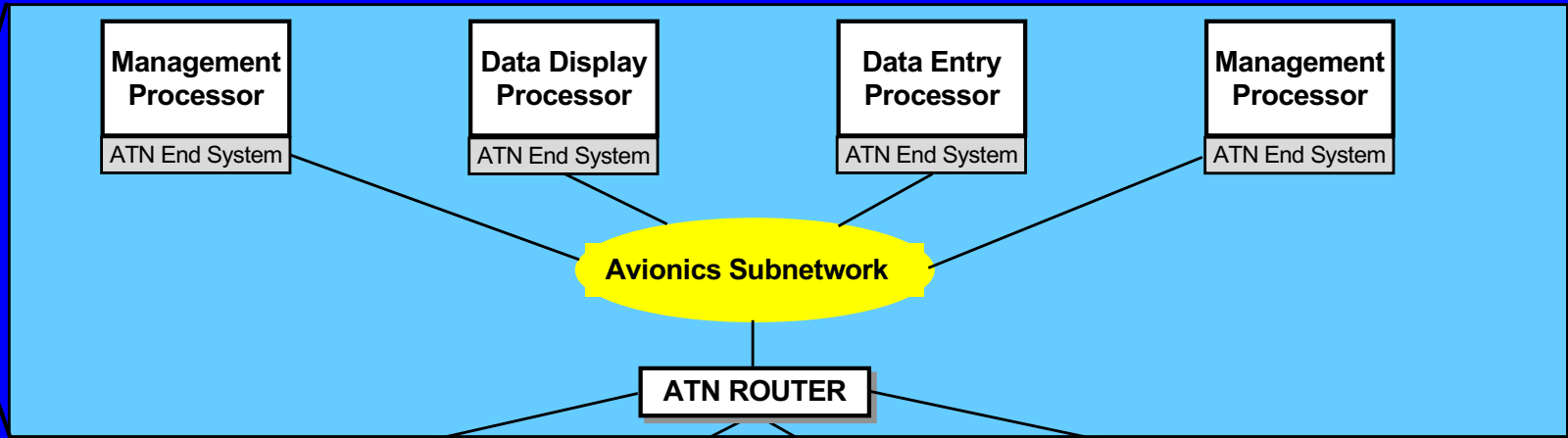

# Evolution of Aviation Wireless Communications



making nets work

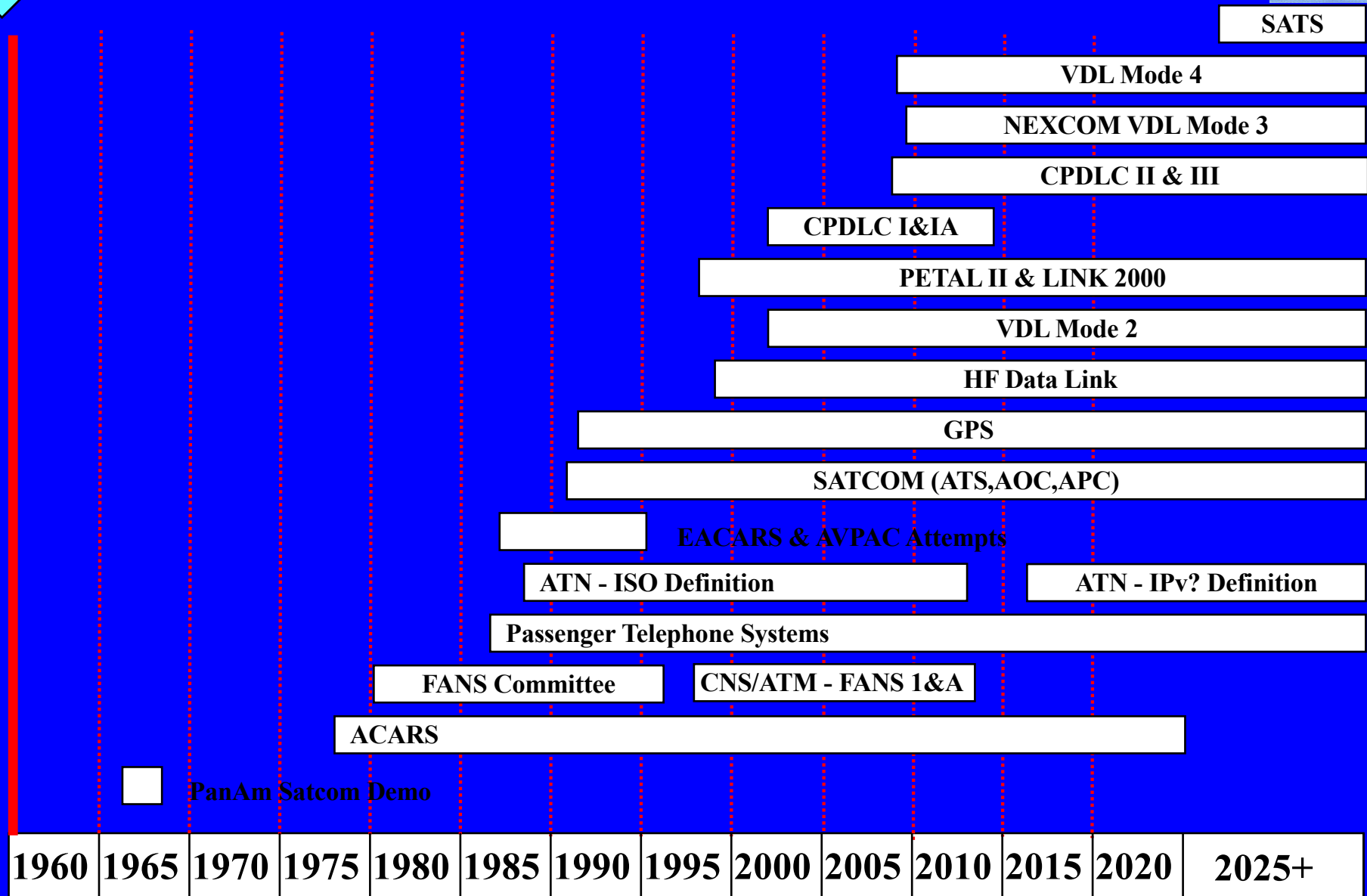

# ATN Architecture



making nets work



Consists of Applications and communication services that allow ground, air-ground, and avionics sub-networks to inter-operate

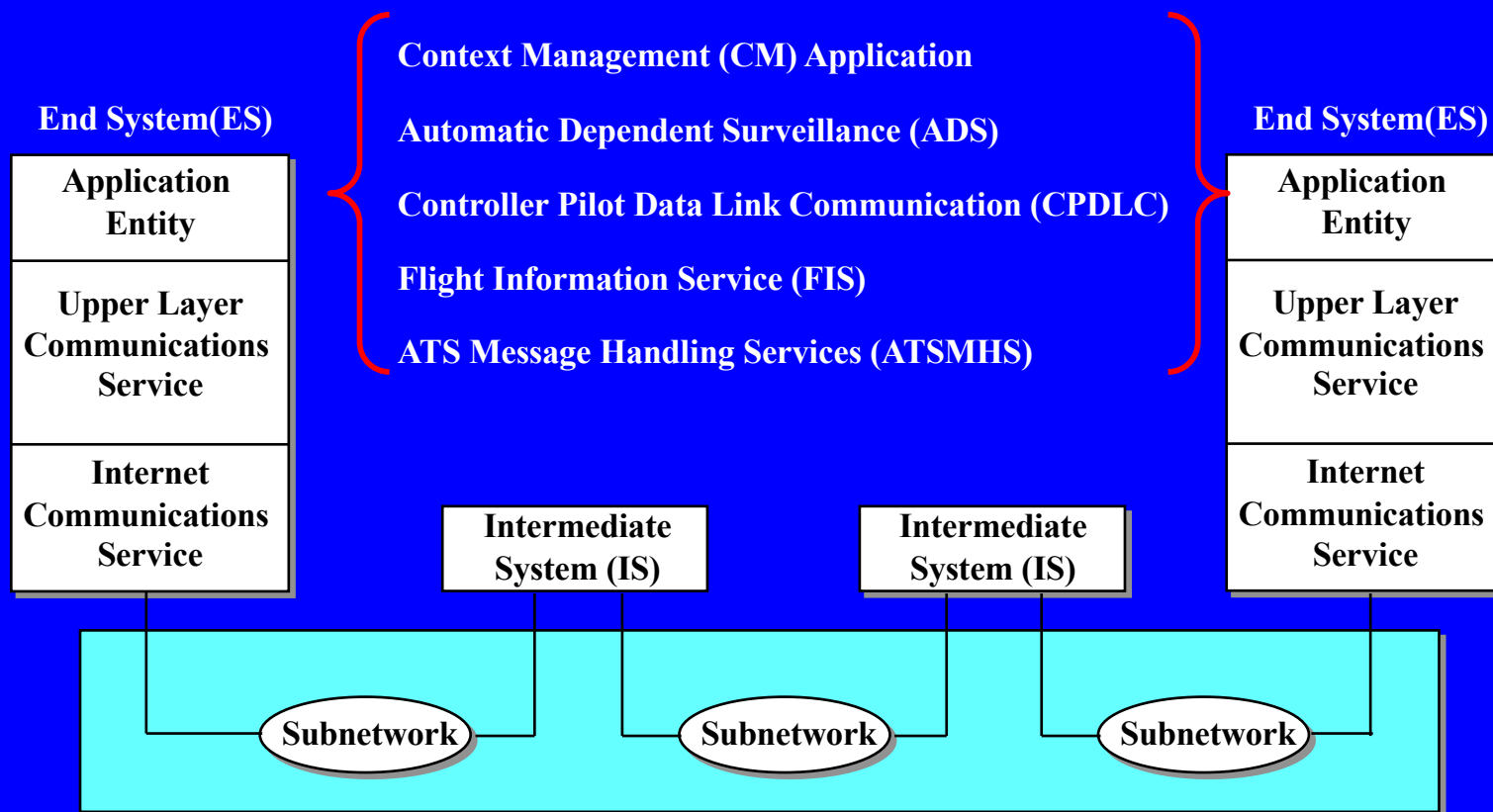



making nets work

# *Aeronautical Communication Requirements*



- **Interoperability with existing subnetworks**
- **High availability**
- **Mobile Communication**
- **Message prioritization**
- **Policy based routing**
- **Security**
- **Bit Efficiency**
- **Support for multiple mobile subnetworks**
- **Mobile platform forms its own Routing domain**



## *Today's ATN Status*

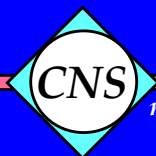

*making nets work*



- **ICAO - 91 Nations Agreement 1991**
- **Published Standards - SARPS Edition 3, end of 2000**
- **Several Cooperative Attempts - Stalled Out**
- **FAA Funded Router Development - ATNS, Inc.**
- **Limited ATN Router Availability**
- **End System Applications under development**
- **Wireless Components not yet “Red Label”**
- **European, Eurocontrol lead early trials ongoing**
- **FAA CPDLC I - Initial Operation 2002**



making nets work

# ATN Protocol Architecture

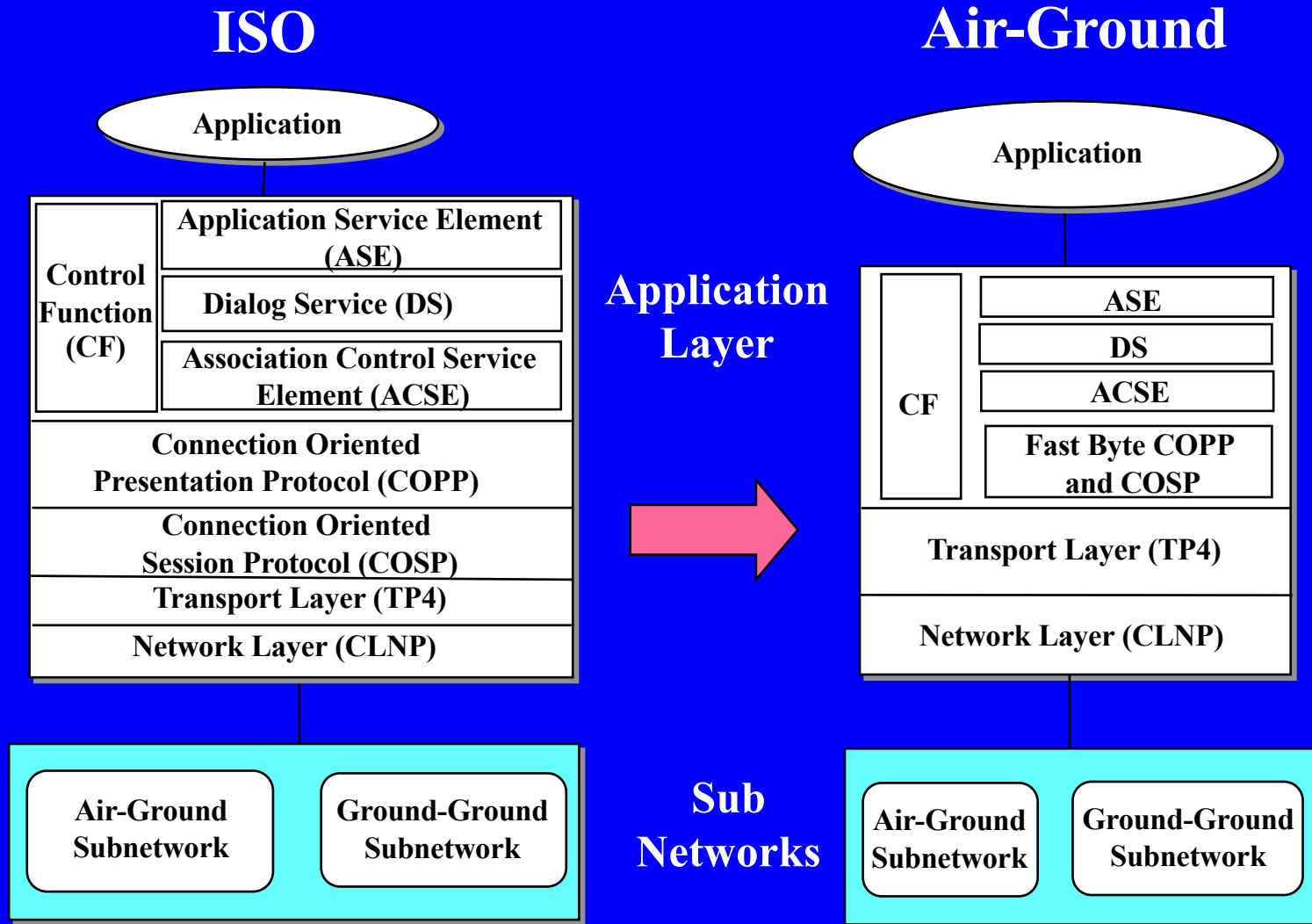

Fast Byte approach selected to obtain bit efficiency over the Air-Ground Link



# ATN and TCP/IP Protocol Architecture



## ATN Architecture

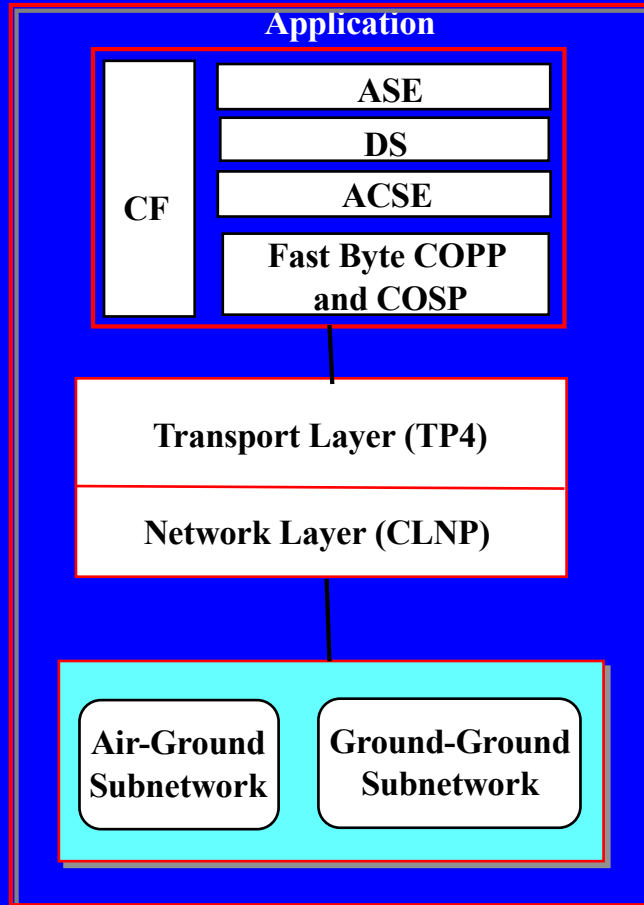

## TCP/IP Architecture

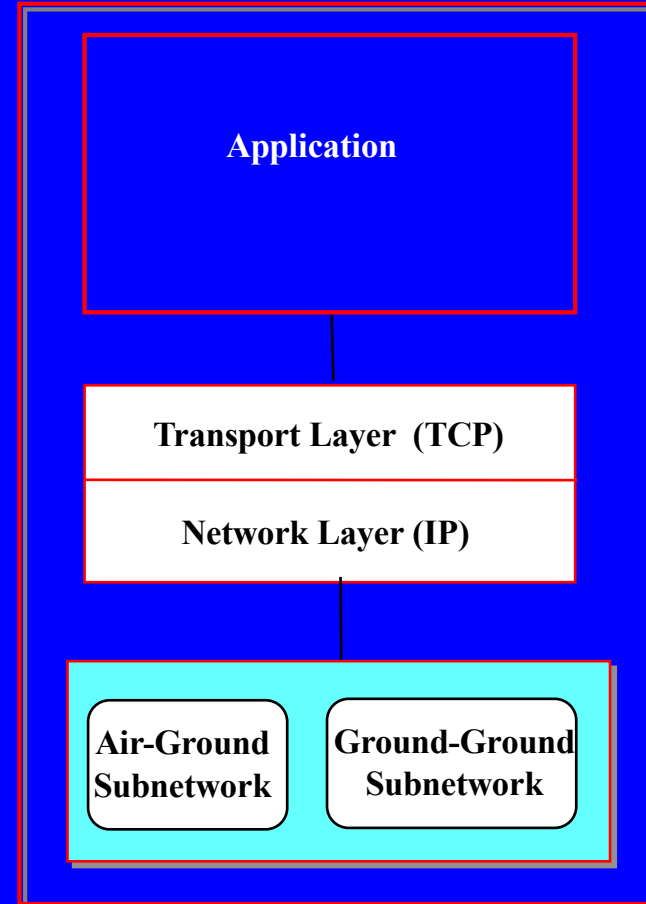

With the Fast Byte enhancements, the two architectures appear similar in structure



making nets work

# TCP and TP4 Features Comparison



**Both support Connection-oriented and Connectionless Transport services**

Function	TCP Protocol	TP4 Protocol
Data transfer	Streams	Blocks
Flow control	Octets	Segments
Error detection	Checksum	Checksum
Error correction	Retransmission	Retransmission
Addressing	16 bit ports	Variable TSAP address
Interrupt service	Urgent data	Expedited data
Security	Supported	Variable in TP
Precedence	Supported	16 bits in TP
Connection termination	Graceful	Non graceful

Source: [Aeronautical Related Applications Using ATN and TCP/IP Research Report](#), prepared by CNS for the NASA Glenn Research Center, November 23, 1999



making nets work

# IP and CLNP Features Comparison



## Both support Connectionless Network services

Function	CLNP	IP
Version ID	1 octet	4 bits
Header length	1 octet, represented in octets	4 bits, represented in 32 bit words
Quality of service	QoS maintenance option	Type of Service (Class)
Segment/fragment length	16 bits, in octets	16 bits, in octets
Total length	16 bits, in octets	16 bits, in octets
Data unit ID	16 bits	16 bits
Flags	Don't segment, more segments	Don't fragment, more fragments
Segment/fragment offset	16 bits, represented in octets	13 bits, represented in units of 8 octets
Lifetime, time to live	1 octet, represented in 500 millisecond units	1 octet, represented in 1-second units
Higher layer protocol	Not present	Protocol identifier
Lifetime control	500 millisecond units	1-second units
Addressing	Variable length	32-bit fixed (128 bits)

Source: [Aeronautical Related Applications Using ATN and TCP/IP Research Report](#), prepared by CNS for the NASA Glenn Research Center, November 23, 1999



making nets work

# IP and CLNP Features Comparison



Function	CLNP	IP
Options	<ul style="list-style-type: none"><li>• Security</li></ul>	<ul style="list-style-type: none"><li>• Security</li></ul>
	<ul style="list-style-type: none"><li>• Priority</li></ul>	<ul style="list-style-type: none"><li>• Precedence bits in TOS (Class)</li></ul>
	<ul style="list-style-type: none"><li>• Complete source routing</li></ul>	<ul style="list-style-type: none"><li>• Strict source route</li></ul>
	<ul style="list-style-type: none"><li>• Partial source routing</li></ul>	<ul style="list-style-type: none"><li>• Loose source route</li></ul>
	<ul style="list-style-type: none"><li>• Record route</li></ul>	<ul style="list-style-type: none"><li>• Record route</li></ul>
	<ul style="list-style-type: none"><li>• Padding</li></ul>	<ul style="list-style-type: none"><li>• Padding</li></ul>
	<ul style="list-style-type: none"><li>• Not present</li></ul>	<ul style="list-style-type: none"><li>• Timestamp</li></ul>
	<ul style="list-style-type: none"><li>• Reason for discard (Error PDU only)</li></ul>	<ul style="list-style-type: none"><li>• Uses ICMP messages</li></ul>

Source: [Aeronautical Related Applications Using ATN and TCP/IP Research Report](#), prepared by CNS for the NASA Glenn Research Center, November 23, 1999



making nets work

# Challenge for the Aeronautical World



## Could TCP/IP protocol meet Aeronautical requirements?

### ■ Benefits:

- Lower Infrastructure cost
- Potential for new services:
  - » VoIP
  - » Multicast
  - » Security
  - » Integration with Public Infrastructure

### Challenges:

- Modifying Political agreement/ Industry Standards
- Addressing Technical Issues for:
  - Mobility Management
  - Policy based routing capability



## Air-Ground (A/G):

- Aeronautical Mobile Satellite
- VHF Data Link
- Mode S
- HF Data link
- Passenger Telephony

## Ground-Ground:

- X.25 PSDNs
- Frame Relay
- LANs
- Leased Lines
- NADIN



# Overview of VDL Modes



making nets work



Mode	Data	Voice	Characteristics
<b>VDL Mode 1</b>	<b>Yes</b>	<b>No</b>	<ul style="list-style-type: none"><li>• Data rate of 1200 bps</li><li>• Channel shared among all using aircraft</li><li>• Channel access based Carrier Sense Multiple Access (CSMA)</li></ul>
<b>VDL Mode 2</b>	<b>Yes</b>	<b>No</b>	<ul style="list-style-type: none"><li>• Uses the same frequency band as Mode1, but uses better data encoding modem</li><li>• Differentially encoded 8-phase shift keying (D8PSK) with channel data rate of 31.5 kbps</li><li>• Channel access based Carrier Sense Multiple Access (CSMA)</li></ul>
<b>VDL Mode 3</b>	<b>Yes</b>	<b>Yes</b>	<ul style="list-style-type: none"><li>• Provide 4 logically independent channels in a 25kHz frequency assignment.</li><li>• Each channel can be allocated to voice or data. Uses differentially encoded 8-phase shift keying (D8PSK) at 31.5 kbps</li><li>• Standard media access control based on 4 slots structure</li><li>• Extended range uses 3 slot structure</li></ul>
<b>VDL Mode 4</b>	<b>Yes</b>	<b>No</b>	<ul style="list-style-type: none"><li>• Uses Self-organizing Time division multiplexing (STDMA)</li><li>• Uses TDMA based short time slots</li><li>• Uses a reservation protocol to gain link access</li></ul>

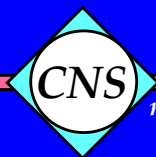

making nets work

# *Subnetworks Requirements*



- **Byte and code independence**
- **Address individual systems**
- **Provide error detection**
  - Undetected error better than 1 in  $10^8$
- **Packet mode technology**
- **Connectionless and Connection mode**
- **Prioritization of data**
  - Important for safety related data
- **QoS Management**
  - Throughput and Transit delay guarantees
- **Mobile subnetworks**
  - Ability to report aircraft joining the subnetwork
  - Ability identify aircraft leaving a subnetwork

# *Mobility and Roaming*



making nets work



- **Mobility between subnetworks while staying in contact**
  - Supported by the data link layer
  
- **ATN must support Roaming between networks**
  - Aircraft may move from one mobile subnetwork to another
  - Aircraft may be simultaneously attached to more than one mobile subnetwork

# Mobile Routing Issues



making nets work



- **Routes cannot be aggregated**
  - Mobile addresses not related to topology
- **Route changes every time aircraft changes point of attachment**
  - High rate of routing updates
- **Routers have to keep a route for each aircraft**
  - ATN size limited by router table capacity



making nets work

## *ATN Solutions for Mobility*



- **Uses Inter Domain Routing Protocol (IDRP) for routing**
- **Implements distributed IDRP directory using Boundary Intermediate Systems (BISs)**
- **Two level directory**
  - **ATN Island concept consisting of backbone BISs**
  - **Home BISs concept**
- **Scalability obtained by the two level structure**
- **Resilience is provided by the distributed approach**



making nets work

# ATN Island Routing Domain Confederation

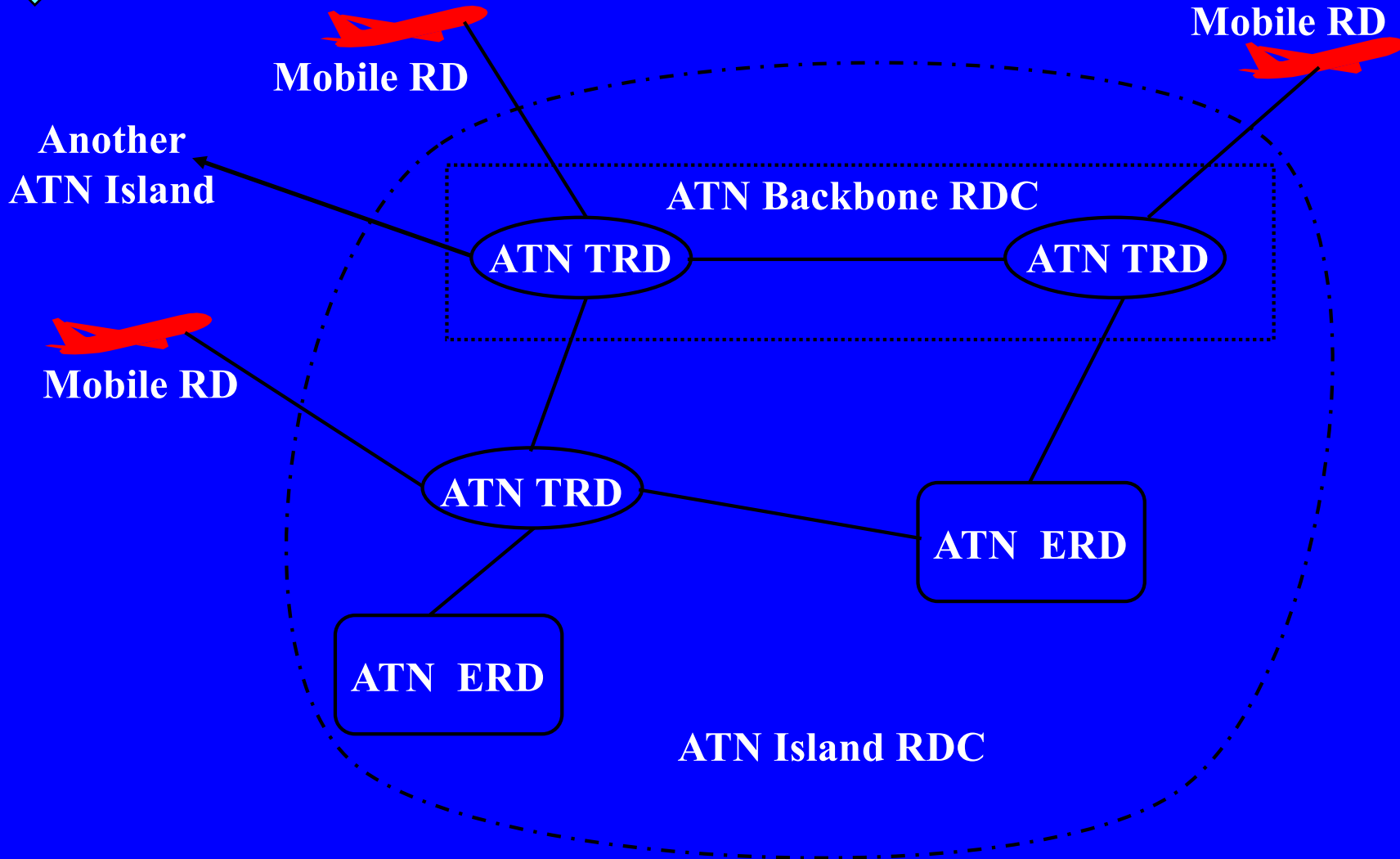



# Mobile Routing Example

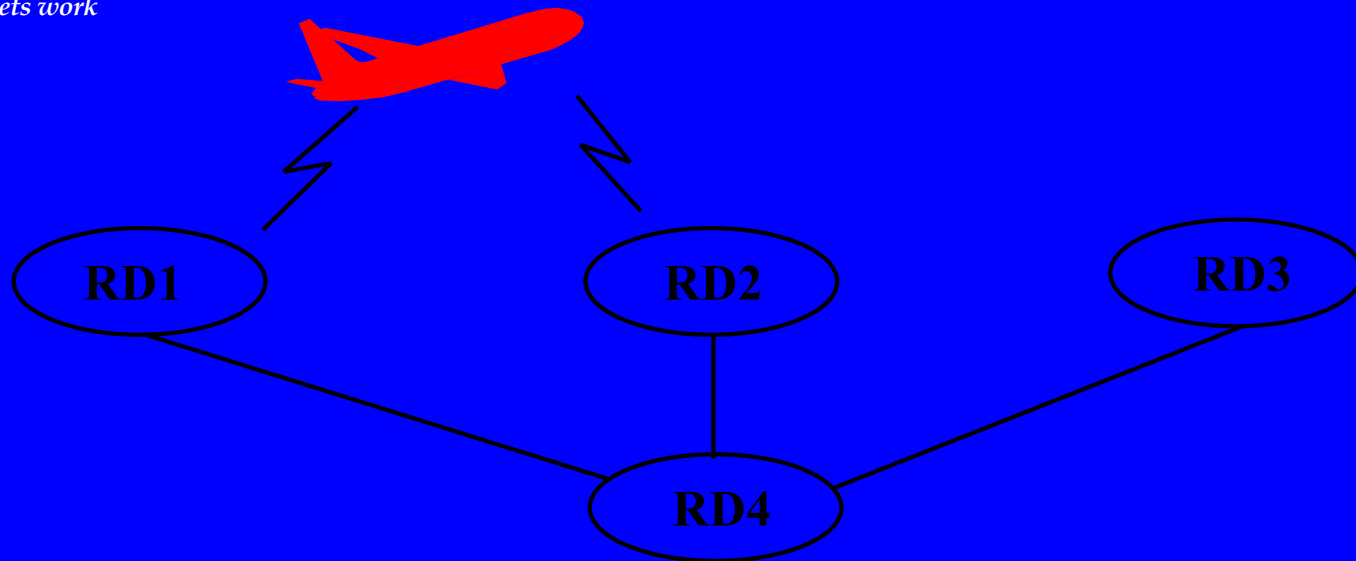

- RD1, RD2 and RD3 support air/ground data links and RD4 depends on the other three (3) for A/G communication.
- Using IDRPs RD1 and RD2 advertise a route to the aircraft and RD4 can choose one of the routes based on Routing policy.



## *Mobile Routing Example*



- As the aircraft travels it may lose contact RD1, RD1 informs others using the route withdraw message.
- RD4 now has one path to the aircraft through RD2 and thus routes all traffic through RD2.
- Further along in the flight, the aircraft may come in contact with RD3. A data link is established and routing information is exchanged. RD3 then advertises a new route to the aircraft.
- RD4 again has two routes to the aircraft and chooses a route based on local routing policy. The aircraft goes through a similar process to select a route.





making nets work

# *ATN Mobile Protocol Requirements*



- Shall support wide variety of mobile communications networks including aeronautical mobile-satellite service (AMSS), VHF digital link (VDL), HF digital link and SSR Mode S. Shall be possible to communicate with airborne avionics in any part of the world.
- Shall support wide range of Organizational and National policies, including the enforcing of restrictions on what types of traffic can pass over both ground and air/ground data links, and control over which air/ground data link types are used by which applications
- BISs shall advertise routes to each other, where a route consists of the set of addresses which identifies the destinations reachable over the router, and information about the route's path including the Quality of Service and Security available over the route.
- Shall support policy based routing that enables users to control external access to their communications resources, and to protect themselves from problems elsewhere in the internetwork.
- The ATN, mobile “platforms” on board an aircraft shall form a Routing Domain and must include an ATN Router that is also a BIS.
- Shall support a two level concept of default route providers (ATN Island and Home) for containing high rate of information flow, and also to avoid the problems of routing instability caused by a rapid turnover of routing information.
- Mobile routing shall support the user requirement that the users can specify, on a per application basis, routing control requirements.



making nets work

# NASA System Testbed Configuration



## Testbed Protocol Stack

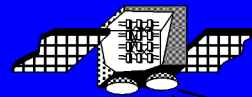
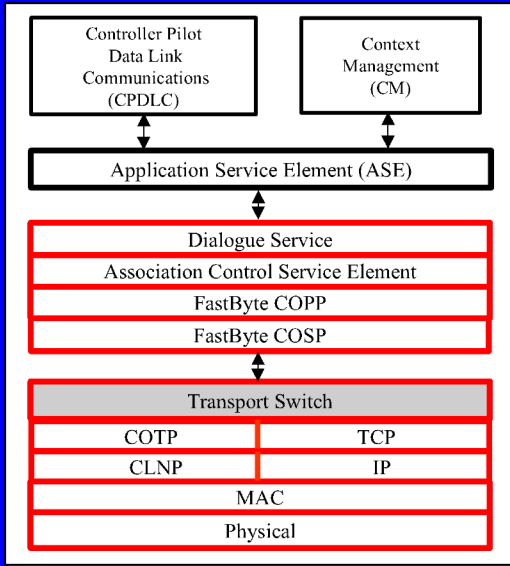

VHF Mode-2

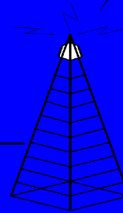

NASA DC-8 Experimental Aircraft

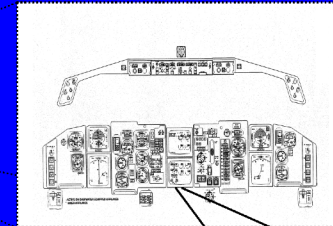
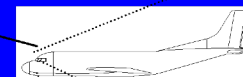

Transceivers

CMU (ATN compliant)

Display 'MCDU'

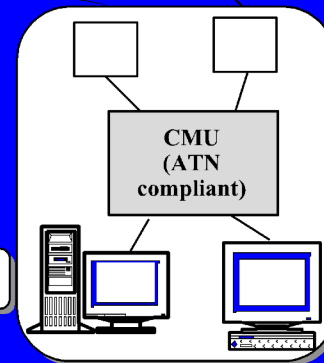
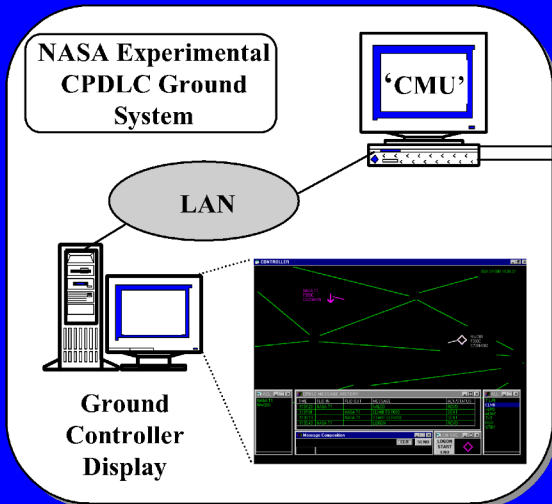

• Telemetry  
• Admin

# Summary

CNS

*making nets work*



- **Aviation's use of TCP/IP could yield significant benefits.**
- **Without a common solution for mobile routing, Aviation's ISO oriented ATN will remain in place.**
- **Adopting IDRP-like mechanisms for mobile IP versus a BGP-like approach is a step in Aviation's direction.**



# Wireless Application Categories (Voice and Data)



- **Air Traffic Management (ATM)**
  - Air Traffic Control (ATC)
  - Air Traffic Services (ATS)
  - Communication, Navigation, & Surveillance (CNS)
- **Airline Operational Communications (AOC)**
  - Flight Operations
  - Maintenance
  - Airport/Ramp Operations
- **Airline Administrative Communications (AAC)**
- **Airline Passenger Communications (APC)**
- **Entertainment**

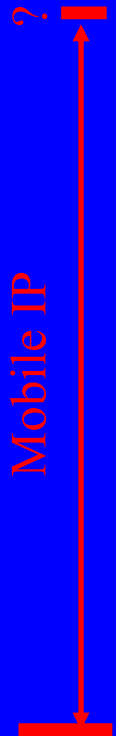

# Acronym List

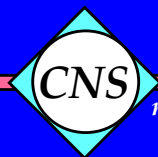

making nets work



<b>ATN</b>	<b>Aeronautical Telecommunication Network</b>
<b>ACARS</b>	<b>Aircraft Communications Addressing and Reporting System</b>
<b>ACSE</b>	<b>Association Control Service Element</b>
<b>AMSS</b>	<b>Aeronautical Mobile-Satellite Service</b>
<b>ASE</b>	<b>Application Service Element</b>
<b>BIS</b>	<b>Boundary Intermediate System</b>
<b>CF</b>	<b>Control Function</b>
<b>COPP</b>	<b>Connection Oriented Presentation Protocol</b>
<b>COSP</b>	<b>Connection Oriented Session Protocol</b>
<b>CPDLC</b>	<b>Controller-Pilot Data Link Communications</b>
<b>DS</b>	<b>Dialogue Service</b>
<b>ERD</b>	<b>End Routing Domain</b>
<b>ICAO</b>	<b>International Civil Aviation Organization</b>
<b>FANS</b>	<b>Future Air Navigation System</b>
<b>IDRP</b>	<b>Inter Domain Routing Protocol</b>
<b>NADIN</b>	<b>North American Digital Information Network (FAA)</b>
<b>PETAL</b>	<b>Preliminary European Test of Air/Ground Data Link</b>
<b>RD</b>	<b>Routing Domain</b>
<b>RDC</b>	<b>Routing Domain Confederation</b>
<b>TRD</b>	<b>Transit Routing Domain</b>
<b>VDL</b>	<b>VHF Digital Link</b>

# *Industry Initiatives*



making nets work



## ■ **ATN**

- **Context Management (CM) Application**
- **Automatic Dependent Surveillance (ADS)**
- **Controller Pilot Data Link Communication (CPDLC)**
- **Flight Information Service (FIS)**
- **ATS Message Handling Services (ATSMHS)**

# *Air Traffic Management (ATM)*

CNS

*making nets work*



- **Predeparture Clearance**
- **Taxi Clearance**
- **Context Management**
- **Controller to Pilot Data Link Communication**
- **Automatic Dependent Surveillance**
- **Waypoint Position Reporting**
- **Emergency Messages**
- **Future Air Navigation System**
- **Oceanic Clearance**
- **Future Free Flight**
- **Flight Information Services**
- **Airport Terminal Information Service**
- **Digital Airport Terminal Information Service**
- **Flight Information Services Broadcast**
- **Notice to Airmen**
- **METAR**
- **Terminal Weather Information to Pilots**
- **Local Area Augmentation System**
- **Wide Area Augmentation System**
- **Cockpit Voice (ATC)**



# ***AOC, AAC, APC and Entertainment***



<b>Airline Operational Communications (AOC)</b>	<b>Airline Administrative Communications (AAC)</b>
<b>Data Link Related System Control, Peripherals, and Subsystems (6 Applications/61 Formats)</b> <b>Flight Operations (14 Applications/30 Formats)</b> <b>Maintenance Operations (6 Applications)</b> <b>Airport/Ramp Area Operations</b> <b>Cockpit Voice Operations (Company)</b>	<b>Airlines Gate Connections</b> <b>Medical Assistance Requests</b> <b>Crew Schedule and Lodging Information</b> <b>Miscellaneous Freetext Crew Information</b> <b>Future Applications – Passenger Handling</b>
<b>Airline Passenger Communications (APC)</b>	<b>Entertainment</b>
<b>Telephony</b> <b>E-Mail</b> <b>Internet Services</b> <b>Facsimile</b>	<b>Games</b> <b>Movies/Videos</b> <b>Gambling</b> <b>Shopping</b> <b>Automated Teller Machines</b>